

ОДНОНАПРАВЛЕННЫЙ НАСОС - СЕРИИ XV

XV-3P

**ВАЛ КОНИЧЕСКИЙ
ФЛАНЕЦ Ø50,8 ЕВРОСТАНДАРТ**

X 3 P 78 02 A B B A

Серия	X	Серия XV
Группа	3	Группа 3
Категория	P	Однонаправленный насос
Рабочий объем	78	38
Фланец	02	Ø50,8 с правым вращением
Вал	A	CO001- Вал конический 1:8 - Ø22, шпонка 4 мм
Корпус	Вход	Входной канал - Ø51 Ø27 M10
	Выход	Выходной канал - Ø51 Ø27 M10
Крышка	A	Стандартная

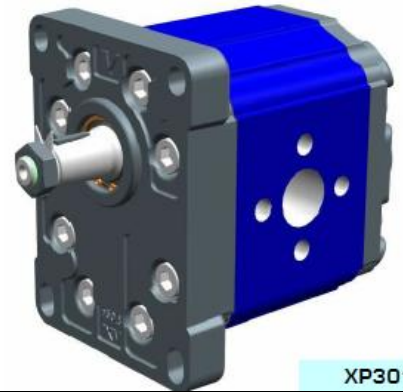

XP301

Таблица технических характеристик

ТИП	Раб. Об. См³ /об	Макс. Давление		КОД																	
		P1 бар	P3 бар	← Левое вращение								Правое вращение →									
				X	3	P	66	01	A	A	A	A	X	3	P	66	02	A	A	A	A
XV-3P/15	14,89	300	320	X	3	P	66	01	A	A	A	A	X	3	P	66	02	A	A	A	A
XV-3P/18	17,37	300	320	X	3	P	68	01	A	A	A	A	X	3	P	68	02	A	A	A	A
XV-3P/21	21,10	280	300	X	3	P	70	01	A	A	A	A	X	3	P	70	02	A	A	A	A
XV-3P/27	26,97	250	270	X	3	P	72	01	A	A	A	A	X	3	P	72	02	A	A	A	A
XV-3P/32	32,27	250	270	X	3	P	74	01	A	B	B	A	X	3	P	74	02	A	B	B	A
XV-3P/38	38,47	250	270	X	3	P	78	01	A	B	B	A	X	3	P	78	02	A	B	B	A
XV-3P/43	43,44	250	270	X	3	P	79	01	A	B	B	A	X	3	P	79	02	A	B	B	A
XV-3P/47	47,16	230	250	X	3	P	80	01	A	B	B	A	X	3	P	80	02	A	B	B	A
XV-3P/51	50,88	230	250	X	3	P	81	01	A	B	B	A	X	3	P	81	02	A	B	B	A
XV-3P/54	54,60	230	250	X	3	P	82	01	A	B	B	A	X	3	P	82	02	A	B	B	A
XV-3P/61	60,81	230	250	X	3	P	83	01	A	C	C	A	X	3	P	83	02	A	C	C	A
XV-3P/64	64,53	210	230	X	3	P	85	01	A	C	C	A	X	3	P	85	02	A	C	C	A
XV-3P/70	70,74	200	220	X	3	P	86	01	A	C	C	A	X	3	P	86	02	A	C	C	A
XV-3P/74	74,46	180	200	X	3	P	87	01	A	C	C	A	X	3	P	87	02	A	C	C	A
XV-3P/90	86,87	150	170	X	3	P	89	01	A	C	C	A	X	3	P	89	02	A	C	C	A

P1) Макс. рабочее давление - P3) Макс. пиковое давление
Для работы насоса в тяжелом режиме рекомендуется проверять допустимый крутящий момент на валу.

Таблица габаритов

ТИП	Вес кг	A мм	B мм	ВХОД			ВЫХОД		
				D	E	F	D	E	F
XV-3P/15	7,010	124,0	61,0	ø20	40	M8	ø20	40	M8
XV-3P/18	7,070	126,0	62,0	ø20	40	M8	ø20	40	M8
XV-3P/21	7,150	129,0	63,5	ø20	40	M8	ø20	40	M8
XV-3P/27	7,250	133,0	65,5	ø20	40	M8	ø20	40	M8
XV-3P/32	7,390	138,0	68,0	ø27	51	M10	ø27	51	M10
XV-3P/38	7,520	143,0	70,5	ø27	51	M10	ø27	51	M10
XV-3P/43	7,630	147,0	72,5	ø27	51	M10	ø27	51	M10
XV-3P/47	7,710	150,0	74,0	ø27	51	M10	ø27	51	M10
XV-3P/51	7,790	153,0	75,5	ø27	51	M10	ø27	51	M10
XV-3P/54	7,870	156,0	77,0	ø27	51	M10	ø27	51	M10
XV-3P/61	8,010	161,0	79,5	ø36	62	M10	ø36	62	M10
XV-3P/64	8,090	164,0	81,0	ø36	62	M10	ø36	62	M10
XV-3P/70	8,220	169,0	83,5	ø36	62	M10	ø36	62	M10
XV-3P/74	8,300	172,0	85,0	ø36	62	M10	ø36	62	M10
XV-3P/90	8,570	182,0	90,0	ø36	62	M10	ø36	62	M10

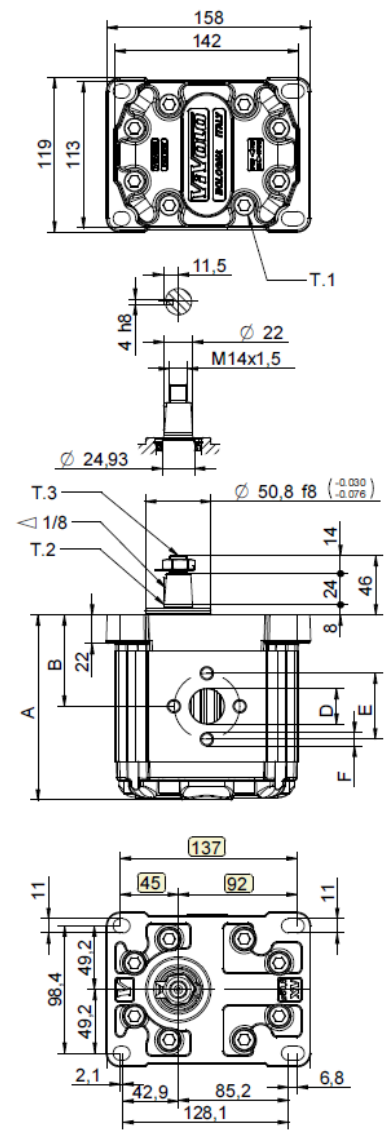

T.1 = 60÷65 [Н-м] - крутящий момент затяжки винтов M10
T.2 = 482 [Н-м] - допустимый крутящий момент на валу
(Примечание: Выбирая вал, всегда проверяйте допустимый крутящий момент).
T.3 = 75 [Н-м] - настройка динамометрического ключа 22

Vivoil Oleodinamica Vivoilo s.r.l. - Sole Shareholder Company - via Leone Ginzburg 2-4 40054 Budrio (BO) Italy tel: +39 051 803689 fax: +39 051 800061

XP301



www.vivoil.com - english

02/07/2009

ФЛАНЕЦ Ø50,8

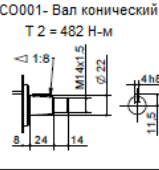
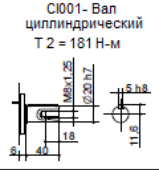
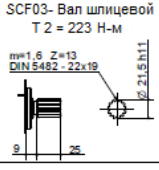
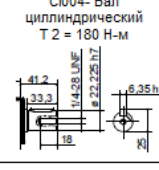
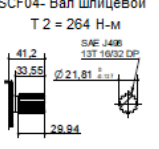
Фланец Ø50,8	
Левое Вращение	Правое Вращение
	
01	02

Вал	
<p>CO001- Вал конический T 2 = 482 Н-м</p> 	<p>CI001- Вал цилиндрический T 2 = 181 Н-м</p> 
<p>SCF03- Вал шлицевой T 2 = 223 Н-м</p> 	<p>CI004- Вал цилиндрический T 2 = 180 Н-м</p> 
<p>SCF04- Вал шлицевой T 2 = 264 Н-м</p> 	

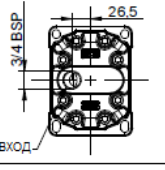
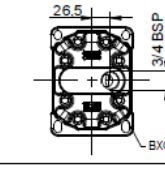
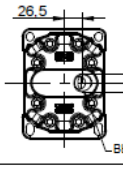
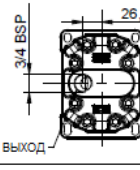
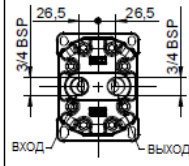
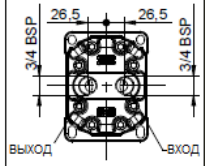
Крышка		
Левое Вращение	Правое Вращение	
		A
		B
		C
		D

Типоразмер	
ТИП	КОД
XV-3P/15	66
XV-3P/18	68
XV-3P/21	70
XV-3P/27	72
XV-3P/32	74
XV-3P/38	78
XV-3P/43	79
XV-3P/47	80
XV-3P/51	81
XV-3P/54	82
XV-3P/61	83
XV-3P/64	85
XV-3P/70	86
XV-3P/74	87
XV-3P/90	89

Стандартные корпуса				
Рабочий Объем См ³ /об	Стандартные резьбы			
	15	A - A	D - D	H - H
18	A - A	D - D	H - H	
21	A - A	D - D	H - H	
27	A - A	E - E	H - H	
32	B - B	E - E	H - H	
38	B - B	E - E	H - H	
43	B - B	E - E	H - H	
47	B - B	E - E	H - H	
51	B - B	E - E	H - H	
54	B - B	E - E	H - H	
61	C - C	F - F		
64	C - C	F - F		
70	C - C	F - F		
74	C - C	F - F		
90	C - C	F - F		

В таблице указаны имеющиеся в ассортименте комбинации стандартных фланцев и резьб.

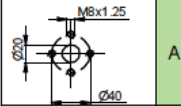
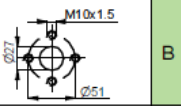
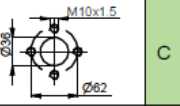
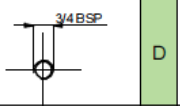
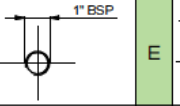
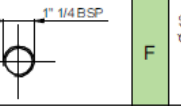
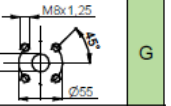
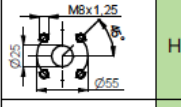
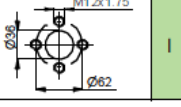
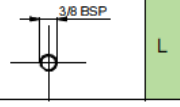
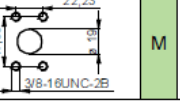
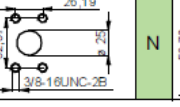
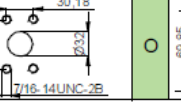
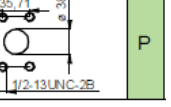
Корпус (резьбы/фланцы)													
	A		B		C		D		E		F		G
	H		I		L		M		N		O		P
Закрытый Корпус	Z												